



ASTRO

Having the right equipment at work increases productivity by up to 10%! Buronomic offers an extensive portfolio that is functional, ergonomic and aesthetic. It can be upgraded with accessories and be perfectly adapted to your business. Choose amongst the materials and styles available to create the office which will best match your needs

**YOUR EVOLUTIVE
BENCH SOLUTION FOR
OPEN SPACE OFFICES**



ASTRO

SOBRE

With their calm design, Astro desks develop your collaborative spaces without compromising on functionality. Its arch metal structure with floating top design is the ideal choice in open spaces to optimise multiple and practical office layouts. Astro furniture can be upgraded to meet communication requirements, with various privacy, accessory and cable management options to make it even more functional.

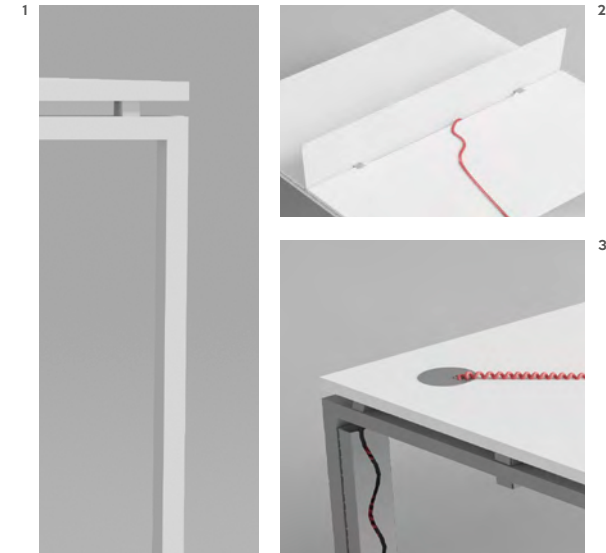

Details

- 1.** Modern and minimalist style of the arch metal leg with raised top. **2.** Removable Plexiglas front space divider for a customised work area. **3.** Magnetic cable down-guide designed especially for the leg.



Materials and warranty

Our industrial know-how guarantees the quality and durability of the materials used to make our furniture.



STRUCTUREX® PANELS

Full panels of particles with melamine surfacing. Counter-balanced and treated against reflection. Thickness 16 to 25 mm. Density 680 kg/m³ for the 25 mm panels. Tested as conforming to abrasion and hot & cold water resistance to the XP D60-050 standard.



5 YEAR GUARANTEE

The quality and durability of the materials enable us to guarantee all our ranges for 5 years under normal conditions of use.



NF ENVIRONNEMENT

Product life cycle checked over the entire production line, from choice of materials to product end of life for environmentally-friendly products.



NF OFFICE EXCELLENCE CERTIFIÉ

The mark of excellence, guarantee of Buronomic's commitment in a corporate social responsibility approach that focuses on people.

+ More details

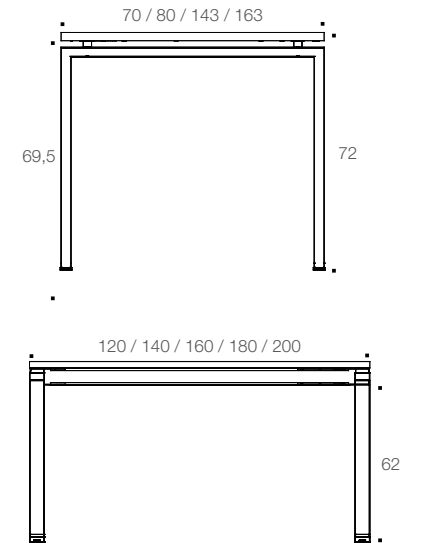

Technical description

- Structure made of Structurex®, 25 mm thickness.
- 2 mm ABS edging.
- Recessed leg on add-on unit to ease lateral movement from one workstation to another.
- Astro range is based on a self-supporting beam system with raised desk tops, forming a full steel underframe with 2 arch legs and a transverse beam.
- Adjustable screw jacks to compensate for any defects in the floor.
- In back to back configuration, a space divider can be fitted in the 3 cm gap provided between the tops.
- Additional sliding top systems with easy to use operating handle allowing a fast access to connections.

Finishes

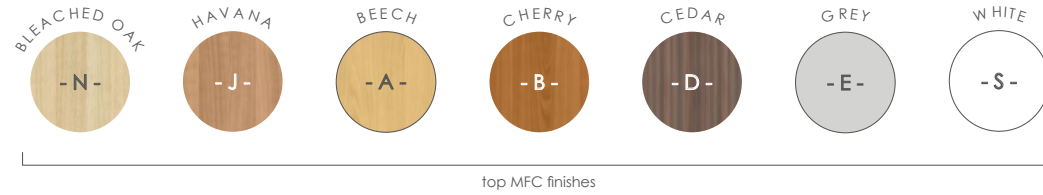

Single desk

STRAIGHT DESK

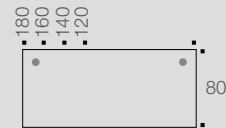

D 70 CM

D 80 CM

Dimensions in cm	Ref.	+ Finishes	Ref.	+ Finishes
D 80 / H 72				
L 120	BK64	+ [] []	AR06	+ [] []
L 140	BK65	+ [] []	BP16	+ [] []
L 160	BT27	+ [] []	BN09	+ [] []
L 180			BN10	+ [] []
L 200			BT29	+ [] []

WAVE DESK

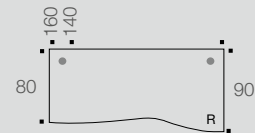

D 80 CM

Dimensions in cm	Ref.	+ Finishes
D 80 to 90 / H 72		
L 140 right hand return	AR56	+ [] []
L 140 left hand return	AR55	+ [] []
L 160 right hand return	AR58	+ [] []
L 160 left hand return	AR57	+ [] []

Single desk



leg

COMPACT DESK

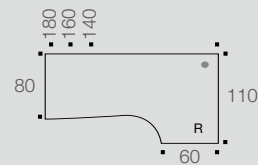

Dimensions in cm	Ref.	+ Finishes
D 80 to 110 / H 72		
L 140 right hand return	BP25	+
L 140 left hand return	BP26	+
L 160 right hand return	BP27	+
L 160 left hand return	BP28	+
L 180 right hand return	BP29	+
L 180 left hand return	BP30	+

COMPACT MANAGER DESK

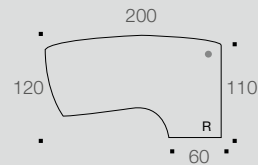

Dimensions in cm	Ref.	+ Finishes
D 110 to 120 / H 72		
L 200 right hand return	AR40	+
L 200 left hand return	AR39	+

DOUBLE WAVE DESK

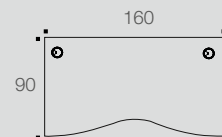

Dimensions in cm	Ref.	+ Finishes
D 90 / H 72		
L 160	AR70	+



top MFC finishes

Single desk



leg

DOUBLE WAVE MANAGER DESK

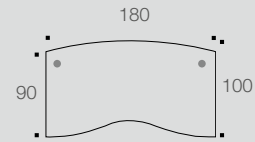

Dimensions in cm	Ref.	+ Finishes
D 100 / H 72		
L 180	AR69	+



top MFC finishes

90° SYMMETRICAL DESK

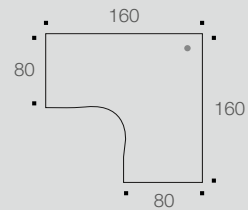

D 80 / H 72		
L 160 (return on arch leg)	AR78	+

120° SYMMETRICAL DESK

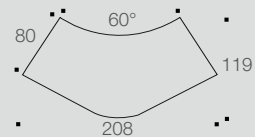

D 80 / H 72		
L 208	AR90	+

Multi-workstations / tops with cable ports



leg

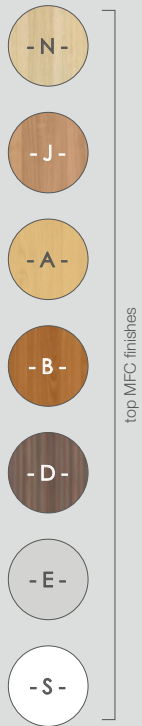

top MFC finishes

STRAIGHT DESK D 70 CM

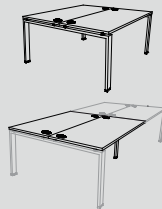

Dimensions in cm	2 BACK TO BACK DESKS STARTER ELEMENT		2 BACK TO BACK DESKS ADD-ON-UNIT	
	Ref.	+ Finishes	Ref.	+ Finishes
D 143 / H 72				
L 120	BQ98	+ [] []	BQ99	+ [] []
L 140	BR00	+ [] []	BR01	+ [] []
L 160	BR42	+ [] []	BR43	+ [] []

STRAIGHT DESK D 80 CM



D 163 / H 72				
L 120	BP17	+ [] []	AR19	+ [] []
L 140	AR11	+ [] []	AR20	+ [] []
L 160	BP18	+ [] []	AR21	+ [] []
L 180	BP19	+ [] []	AR22	+ [] []

Multi-workstations / tops with scalloped edge



leg

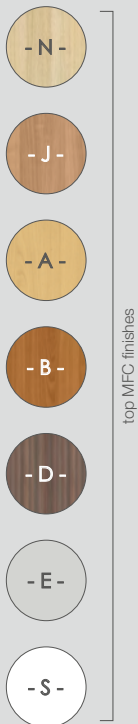

top MFC finishes

STRAIGHT DESK D 70 CM



Dimensions in cm	2 BACK TO BACK DESKS STARTER ELEMENT		2 BACK TO BACK DESKS ADD-ON-UNIT	
	Ref.	+ Finishes	Ref.	+ Finishes
D 143 / H 72				
L 120	BK69	+ [] []	BK71	+ [] []
L 140	BK70	+ [] []	BK72	+ [] []
L 160	BR44	+ [] []	BR45	+ [] []

STRAIGHT DESK D 80 CM



D 163 / H 72				
L 140	BR48	+ [] []	BR49	+ [] []
L 160	BK75	+ [] []	BK77	+ [] []
L 180	BK76	+ [] []	BK78	+ [] []

Multi-workstations / sliding top



leg

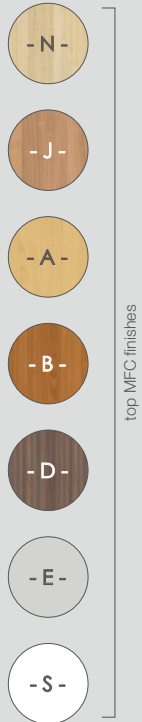

top MFC finishes

STRAIGHT DESK D 70 CM

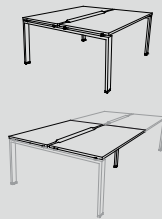

Dimensions in cm	2 BACK TO BACK DESKS STARTER ELEMENT		2 BACK TO BACK DESKS ADD-ON-UNIT	
	Ref.	+ Finishes	Ref.	+ Finishes
D 143 / H 72				
L 120	BS32	+ [] []	BS35	+ [] []
L 140	BS33	+ [] []	BS36	+ [] []
L 160	BS34	+ [] []	BS37	+ [] []

STRAIGHT DESK D 80 CM



Dimensions in cm	2 BACK TO BACK DESKS STARTER ELEMENT		2 BACK TO BACK DESKS ADD-ON-UNIT	
	Ref.	+ Finishes	Ref.	+ Finishes
D 163 / H 72				
L 140	BS39	+ [] []	BS43	+ [] []
L 160	BS40	+ [] []	BS44	+ [] []
L 180	BS41	+ [] []	BS45	+ [] []

- 100 -

- 020 -



legs and metal beam

- 250 -

- 590 -

- 670 -

- 170 -

- 430 -

- 890 -

- 320 -

top MFC finishes

Components

STRAIGHT DESK
WITH CABLE PORT

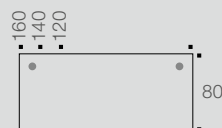

D 70 CM

D 80 CM

Dimensions in cm	Ref.	+ Finish	Dimensions in cm	Ref.	+ Finish
L 120	8C1	+ █	L 120	Q58	+ █
L 140	8C3	+ █	L 140	Q59	+ █
L 143	9E7	+ █	L 160	Q60	+ █
L 160	9E6	+ █	L 180	Q61	+ █
L 163	9E8	+ █	L 200	9E9	+ █

STRAIGHT DESK
WITH SCALLOPED EDGE

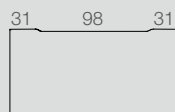

D 70 CM

D 80 CM

Dimensions in cm	Ref.	+ Finish	Dimensions in cm	Ref.	+ Finish
L 120	8C2	+ █	L 140	9E4	+ █
L 140	8C4	+ █	L 160	8C5	+ █
L 160	9E5	+ █	L 180	8C6	+ █

- 100 -

- 020 -



legs and metal beam

- 250 -

- 590 -

- 670 -

- 170 -

- 430 -

- 890 -

- 320 -

top MFC finishes

Components

LEGS

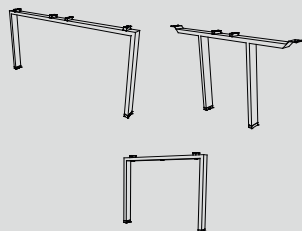

Dimensions in cm	Ref.	+ Finish
D 60	Q01	+ L
D 70	9C4	+ L
D 80	Q02	+ L
D 143	9C6	+ L
D 143 recessed add-on leg	9C7	+ L
D 163	Q06	+ L
D 163 recessed add-on leg	Q16	+ L

BEAM

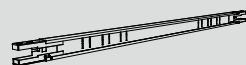

L 120	Q07	+ L
L 140	Q08	+ L
L 160	Q09	+ L
L 180	Q10	+ L
L 200	Q11	+ L
return for desk D 70	9C5	+ L
return for desk D 80	Q12	+ L



leg



top MFC finishes

Options

DOUBLE METAL CABLE TRAY

Description	Dimensions in cm	Ref.
Spécific for sliding tops Aluminium finish	D 58,5 / H 13,5 / L 95	BS461K

EXTENSION

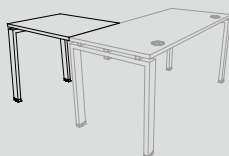

Description	Dimensions in cm	Ref.	+ Finishes
For straight desk D 70 cm For straight desk D 80 cm	D 60 / L 80	BK66 AK23	+ <input type="checkbox"/> + <input type="checkbox"/>

DECORATIVE INFILL

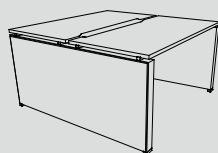

1 set to fit 1 leg frame	D 70	BT353	+ <input type="checkbox"/>
	D 80	BT363	+ <input type="checkbox"/>
	D 143	BK813	+ <input type="checkbox"/>
	D 143 recessed add-on leg	BK823	+ <input type="checkbox"/>
	D 163	BK833	+ <input type="checkbox"/>
	D 163 recessed add-on leg	BK843	+ <input type="checkbox"/>



FIND YOUR LOCAL DEALER

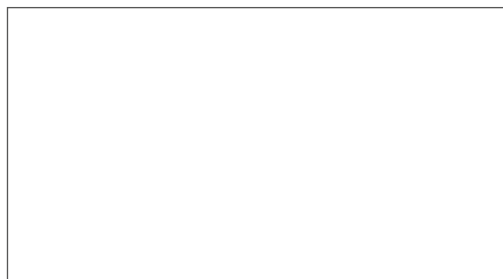

WWW.BURONOMIC.COM